

MOTION SENSOR 360 - VOLT FREE

M360-W-VOLF (WHITE) ----- M360-B-VOLF (BLACK)

FARADITE

OVERVIEW

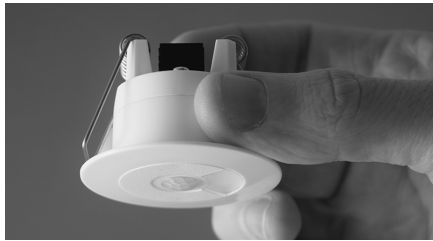

The Faradite Motion Sensor 360 - Volt Free is a low profile passive infrared ceiling mounted motion sensor. It's designed for use with home/building/lighting control systems that have volt free / dry contact inputs.

TECHNICAL DATA

Power supply (consumption)	5V-35V DC 3mA
Solid state relay - max load current	80ma
Solid state relay - on resistance	16 OHMS
Solid state relay - off-state leakage current	1uA
Default state	Normally open
Ambient temperature	0-50 °C (indoor only)
IP rating	IP20
Range (Note 1)	5M
Max mounting height	3m (for optimal performance)
Motion output timeout (see motion output diagram)	1 second
Mounting hole	35mm (40mm Fire rated)
Push-fit connector	AWG 20- 24 CAT5 / CAT6 / CAT7
Standards	EN 61000-6-1 EN 61000-6-3

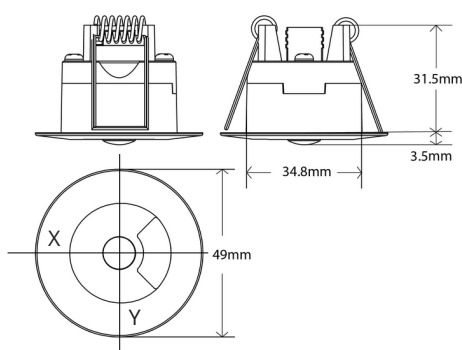

OBSERVATION AREA

At 2.5M it gives a 5.6M * 6.6M observation area.

At 3M it gives a ~8M diameter, as shown below.

The following conditions have to be met to detect motion:

1. Movement speed: 1.0m/s
2. Target concept is a human body (Min object size: ~700x250mm)
3. The temperature difference between the target and the surroundings must be greater than 4 °C when mounted at 5M

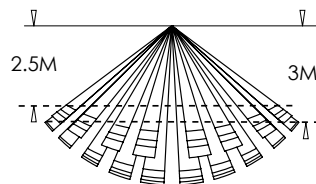

2.5M Height - Observation area

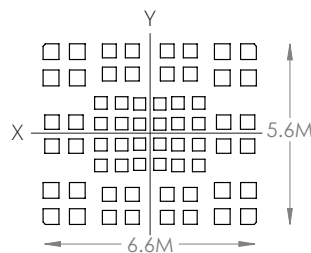

3M Height - Observation area

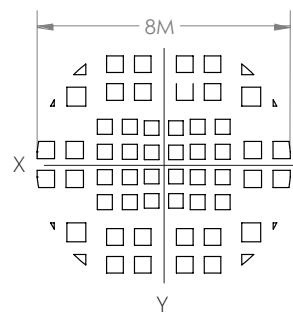

ELECTRICAL CONNECTIONS

It is recommended to use CAT cable to connect the motion sensor to the control system. Stranded cable can be used (20-24 AWG) but please insert the supplied tool to open the spring before inserting the wire.

- 1: Strip the cable back 6mm
- 2: Push into circular hole
- 3: To remove the wire insert the supplied tool or a small screwdriver in the slot behind the wire

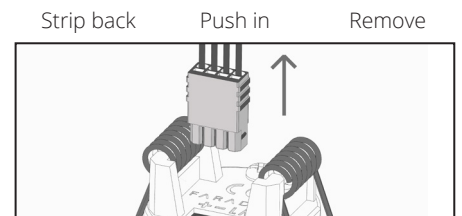
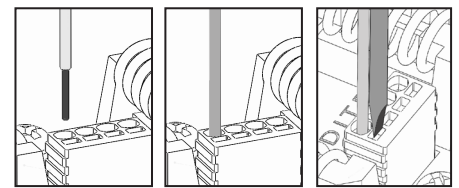

Pull to remove connector from motion sensor

FIRE RATING

The stand-alone Motion Sensor 360 - Volt Free is not fire rated. To achieve a 60 minute fire rating to BS 476: Part 21 1987, the optional Fire IDR must be fitted to the Motion Sensor 360 - Volt Free. The Fire IDR is an optional extra.

EQUIVALENT CIRCUIT

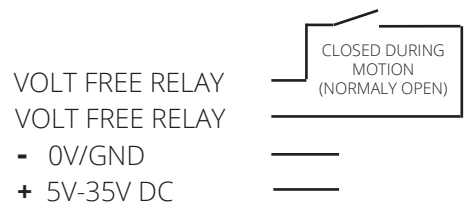

MOTION OUTPUT

NOTE: After applying power, the sensor will calibrate for roughly 8 seconds; during this period no motion will be reported.

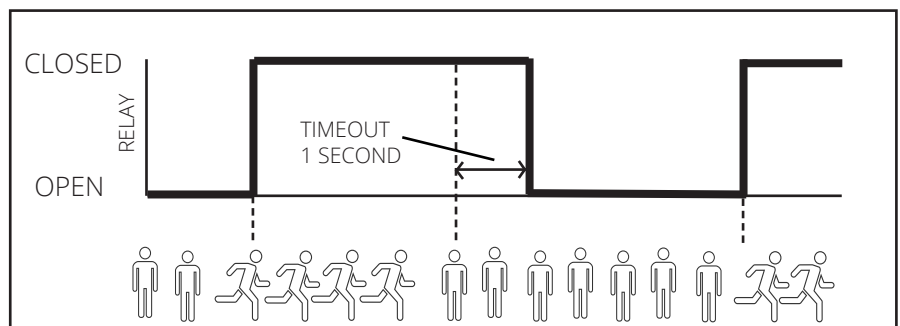

Note 1: Please note that the specified range is 5m but under optimal conditions the sensor might detect movement at a much longer range

INSTALLATION



**USE A 35mm
HOLE SAW FOR
INSTALLATION**

To install the Faradite Motion Sensor 360 - Volt Free, cut a 35mm hole using a suitable hole saw. Fold the spring clips upwards and push through the hole. If you are using the optional Fire IDR to achieve a 60 minute fire rating to BS 476: Part 21 1987, then a 40mm hole will be required.

MOUNTING & SAFETY PRECAUTIONS

1) Do not under any circumstance use these sensors outside the range of their ratings shown in the technical data.

2) Faradite is committed to making products of the highest quality and reliability. Nevertheless, all electrical components are subject to natural deterioration, and the product durability will depend on the operating environment and conditions of use.

3) Please note that the sensor can detect heat sources other than the human body, such as:

- a) Small animals
- b) Direct sun light, incandescent lamps, car headlights (even if the heat source is outside the detection area)
- c) Sudden temperature change inside or around the detection area i.e. hot or cold winds/drafts or vapour from a humidifier can affect the performance of the sensor

4) Please note that the sensor will have difficulty sensing the heat source if it is behind glass, acrylic or similar materials, as these materials may not allow a correct transmission of infrared rays

SENSITIVITY ADJUSTMENT

The sensor has been designed for optimal sensitivity. It is not recommended to change the sensitivity setting unless it is found to be necessary. To adjust the sensitivity, remove the two screws and turn over the circuit board. The small potentiometer can be used to adjust the sensitivity.



INSTALLATION GUIDE FOR VARIOUS CONTROLLERS

CONNECTION TO LUTRON

Connection to Lutron is simple: One side of the relay should be connected to the "INPUT" of a contact closure input (CCI) and the other side should be connected to the "COMMON" of the CCI. Any 5-35V power supply can be used to power the sensor.

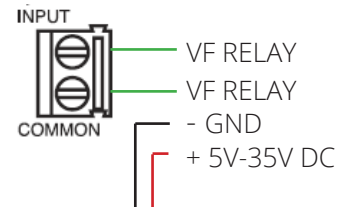

5V-35V POWER SUPPLY

CONNECTION TO CRESTRON

Connection to Crestron is simple: connect one side of the relay to a digital input and the other side to GND (G) and configure the input as a dry contact. The sensor can be powered using any available 5-35V supply.

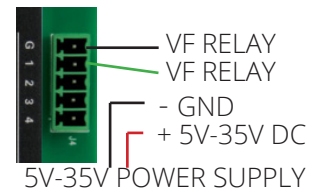

5V-35V POWER SUPPLY

CONNECTION TO LOXONE

Connection to Loxone is simple: connect one side of the relay to a digital input on the MiniServer / Extension / Nano DI Tree / Nano IO Air and the other side to 24V. Simply provide the 24V supply from the power supply in the cabinet or the 24V output of a Nano IO Air if retrofitting.

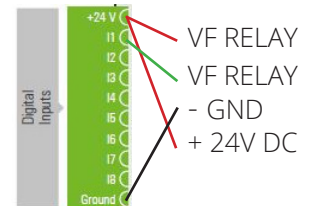

CONNECTION TO CONTROL4

Connection to Control4 is simple: connect one side of the relay to the "SIGNAL" input on a contact closure and the other side of the relay to the 12V power supply. Simply provide the sensor power using the +12V and GND outputs of the contact closure or any other 5V-35V supply. When using a contact closure the Control4 generic motion sensor driver can be used. You will need to tick the invert tick box on the driver as the sensor is "normally open".

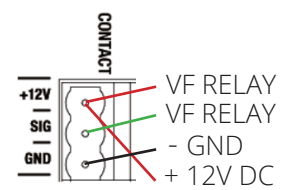

Janus Technology have written a driver that integrates the Faradite Motion Sensor 360 - Volt Free with Control4, via a Brainboxes' I/O device as an alternative to a contact input. Search for "Faradite Janus Technology driver" for more info.

THE SENSOR CAN ALSO BE USED WITH MANY OTHER SYSTEMS THAT HAVE A VOLT FREE / DRY CONTACT INTERFACE

Directive 2014/30/EU (Electromagnetic Compatibility (EMC))
Directive 2012/19/EU (WEEE)
Directive 2011/65/EU (RoHS)

Harmonised standards: EN 61000-6-1 Immunity for residential, commercial and light-industrial environments
& EN 61000-6-3 Emission standard for residential, commercial and light-industrial environments



RoHS CE

FARADITE

For further support & datasheets in other languages
please visit: faradite.com