

OPERATING INSTRUCTIONS

euLINK DALI Port

Revision 01

The euLINK DALI port is a peripheral module for euLINK and for euLINK Lite gateways that connects them to the DALI bus to issue commands to lighting fixtures and read their status. The euLINK gateway equipped with a DALI port works as a Master IEC62386 type II. Up to 4 DALI ports, up to 4 independent buses, can be connected to one euLINK gateway. The recommended number of DALI ports for the simpler euLINK Lite gateway is 2. The euLINK DALI port does not contain a bus power supply, so an external DALI bus power supply must be connected.

Technical details

Supply voltage:	5V DC, derived from the gate
Power consumption:	Up to 50mW (10mA)
Protections:	Galvanic isolation up to a voltage of 3.75 kV, resistance to connection of DA-DA terminals to a voltage of 240V AC
Interfaces:	DALI Control Line (DA-DA)
Cable cross-section:	- wire: 0.2 – 1.0 mm ² - strand: 0.3 – 0.6 mm ² (ferrule)
Enclosure dimensions:	36 x 90 x 58 mm
Width in modules:	2 TE modules on DIN rail
IP rating:	IP20
Operating temperature:	0°C to +40°C
Relative humidity:	≤90%, no condensation



Communication parameters

Compatibility with DALI luminaires:	According to the standard IEC 62386
Operating mode:	Master IEC62386 type II
Supported telegrams:	8-bit, 16-bit, 24-bit
DALI command types:	DT6 and DT8 ^{*)}
Communication with the euLINK gateway:	I ² C Bus
I ² C addresses:	32, 33, 34 and 35

^{*)} Not all Home Center controllers support DT8 lighting fixtures directly (eg "Tunable-White" fixtures). Therefore, it may be necessary to configure the luminaire for an operation mode consistent with DT6.

Compliance with EU Directives

Directives: RED 2014/53/EU
RoHS 2011/65/EU

	Eutonomy certifies that this equipment is in compliance with the essential requirements and other relevant provisions of the above directives. The declaration of conformity is published on the manufacturer's website at: www.eutonomy.com/ce/
	At the end of its useful life this product shall not be disposed with other household or municipal waste. Disposing of this product correctly will help save valuable resources and prevent any potential negative effects on human health and the

	environment, which could otherwise arise from inappropriate waste handling.
--	---

Package contents

The package contains:

1. euLINK DALI Port
2. I²C 10-wire strip 20cm long
3. Operating instructions

If anything is missing, please contact your seller. You can also call or e-mail us using details that can be found at the manufacturers website: www.eutonomy.com.

Drawings of kit components

All dimensions are given in millimetres.

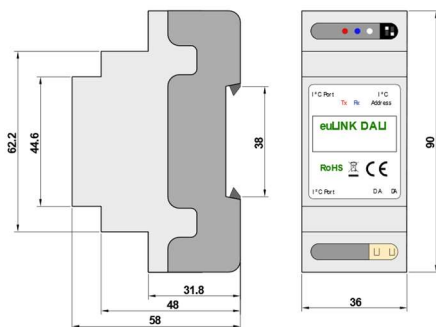

euLINK DALI view:





Application of the euLINK DALI Port

The task of the euLINK gate with a DALI port is to create a bridge between the DALI luminaires and the smart home controller (e.g. FIBARO Home Center). Before connecting the euLINK DALI port, the lighting system must be commissioned and tested. This also includes addressing luminaires, assigning them to groups and defining DALI scenes. The installer then physically connects the euLINK gateway via the DALI port to the bus. After checking the connectivity with the lighting fixtures, the euLINK gateway brings their uniform re-presentation to the smart home controller configuration, enabling two-way communication between the controller and DALI luminaires.

Considerations and cautions

	Please read the instructions carefully prior to installation. The instructions contain important guidelines which, when ignored, can lead to danger to life or health. The manufacturer of the equipment shall not be responsible for any damage resulting from the use of the product in a manner non-compliant with the operating instructions.
	DANGER Electrocution risk! The equipment is intended for operation in the electrical installation. Incorrect wiring or use can result in a fire or an electric shock. All installation works can be performed only by a qualified person holding licenses issued in accordance with the regulations.

	DANGER Electrocution risk! Before carrying out any rewiring works on the equipment, it is mandatory to disconnect it from the power mains using a disconnector or a circuit breaker in the electrical circuit.
	The equipment is intended for indoor use (IP20 rating).

Place of installation of the euLINK DALI

The euLINK Gateway and DALI Port can be installed in any power distribution board equipped with a DIN TH35 rail. If possible, it is recommended to select a location in the distribution board with even the slightest air flow through the ventilation openings in the enclosure, since even simple cooling slows down the processes of ageing of electronic components, ensuring trouble-free operation for many years.

It is recommended to find the optimal installation location for the euLINK DALI Port on the DIN rail before engaging the lower rail holder, as moving the module will be much more difficult when it is secured. The DALI port is connected to the euLINK gateway using a 10-wire ribbon cable with Micro-MaTch connectors supplied with the module. The ribbon length does not exceed 25 cm, so the peripheral module must be located in the immediate vicinity of the gateway (on either side).



Connecting the euLINK DALI Port to the bus

Physical connection of the euLINK DALI Port to each bus requires compliance with its topology, addressing and other specific parameters (e.g. bus supply).

For the DALI bus, the installer has to:

- Provide bus power using a specialized power supply (16V, 250mA)
- Give DALI fixtures unique addresses from 0 to 63
- Assign luminaires to groups and DALI scenes
- Make sure that the bus length does not exceed 300 m (with a cable cross-section of 1.5 mm²)
- Check the operation of all luminaires and controls (e.g. motion detectors, button converters, etc.)

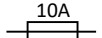
When connecting the DALI bus wires to the DA-DA terminals, you do not need to pay attention to their sequence, because the DALI devices are not sensitive to signal polarity. It also does not matter to which of the 2 I²C sockets the tape to the gate will be connected.

	NOTE! The installed device can be connected to the power mains only by a person qualified to carry out electrical works, holding licenses issued in accordance with the regulations.
	Before commencing any installation works, please make sure that the mains power supply is disconnected at the distribution board by means of an over-current circuit breaker dedicated for the equipment.
	If there are reasonable grounds to suspect that the equipment is damaged and cannot be operated safely, do not connect it to the power mains and protect it against accidental powering.

The DALI buses are galvanically separated from the euLINK gateway and from its power supply.

If the bus is too long or the number of luminaires exceeds 64, you can divide the bus into several smaller segments. Up to 4 DALI ports can be connected to the euLINK gateway simultaneously. In the case of the euLINK Lite model, there should be no more than 2 DALI ports. The method of cascading DALI ports is illustrated in the diagram below:

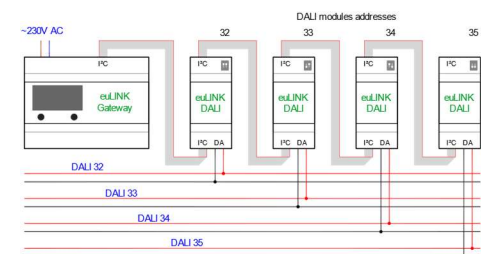

Each DALI port must have a unique I²C address set for the euLINK gateway to distinguish between them. Address setting is done by moving 2 sliders on the DIP switch, visible at the top of the DALI port board. Right next to the DIP switch is a multi-coloured LED that indicates the set address. The following 4 I²C addresses are possible:

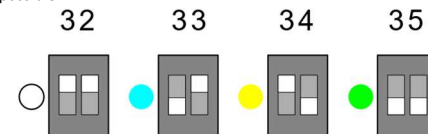

DALI ports with the same address cannot be connected to one euLINK gateway, so each LED in the port cascade should glow in a different colour. The state of the DIP switch is read only once when powered up. So it is best to set the I²C addresses before turning on the power so that the change is noticed. There are two more diagnostic LEDs on the DALI port board: the red Tx, which flashes when transmitting, and the blue one, which is lit continuously as long as the DALI port is connected to a properly powered DALI bus. In addition, the blue Rx LED briefly dims when receiving data from the DALI bus.

Basic configuration of the euLINK DALI Port

It is worth starting the construction of the system by creating several sections in the euLINK gateway configuration in the "Rooms" menu (e.g. Ground floor, First floor, Garden) and individual rooms (e.g. Living room, Kitchen, Garage) in each section. It is best to get a list of sections and rooms from your smart home controller if you have already configured access to it.

Then, in the "Configuration" -> "Hardware interfaces" menu, add new or modify the existing DALI buses by selecting their I²C addresses from the list of recognized DALI ports. It is worth giving each bus a friendly name related to the location of the bus. Then, in the "Devices" -> "Add DALI devices" menu, select the bus that will be scanned for DALI luminaires. Perhaps a new scan will not be needed because the euLINK gateway scans the buses automatically after adding them and after restarting. If, however, new luminaires have been added to the DALI installation in the meantime, a scan of the relevant bus must be started. During normal operation, several control devices can be connected to one DALI bus, but only one of them at a time can perform a bus scan to avoid scanning errors.

DALI luminaire or group of luminaires found using the "On" and "Off" buttons. For selected luminaires or their groups, check the "Add this device" field, give it a friendly name, assign it to a room

and save the result. Similarly, you can create and assign a scene controller to a selected room. After you have finished adding DALI luminaires, you can return to the main "Home" menu and check the operation of each of them by clicking on the corresponding icons. If the diagnostics was successful, you can enter the configuration of each luminaire and import it to the Home Center controller using the "Create controller device" button. Within a few seconds in the Home Center controller a driver will be created with the buttons "On", "Off" and "Toggle", as well as with a slider to adjust the brightness, if the luminaire has been marked as dimmable. Necessary icons and global variables for use in scenes will also be brought in. After refreshing the application on smartphones and computers, the control of DALI luminaires should work.

Installation schematic diagram

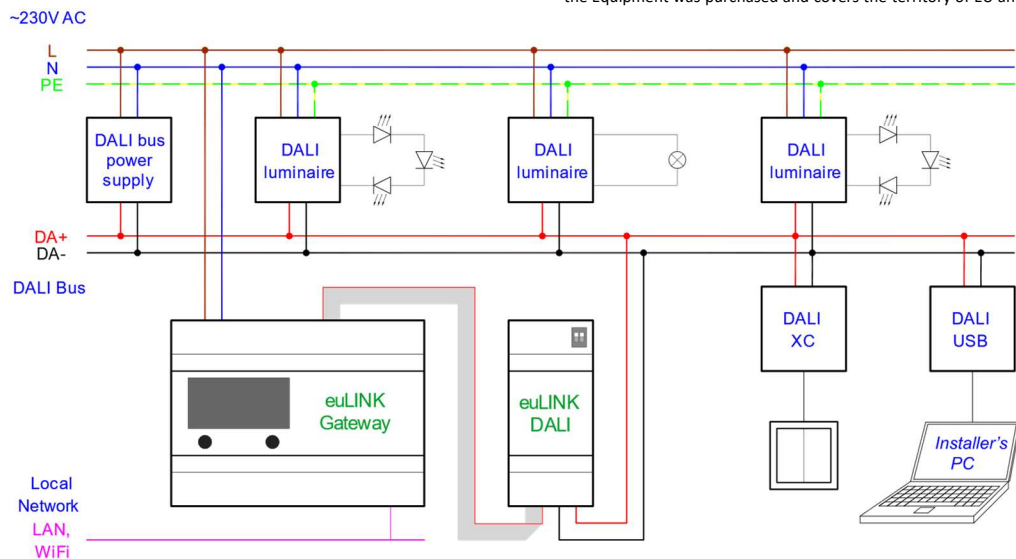

The installer's computer with the DALI programmer visible in the diagram should be used to address and group DALI luminaires and to carefully check the entire installation before integration with the euLINK gateway. If the DALI installation does not work properly, the integration will not improve this condition, and it is very possible that it will worsen it.

Service

	Do not perform any repairs on the device. All repairs shall be performed by a specialist service designated by the manufacturer. Improperly performed repairs endanger the safety of users.
--	---

In case of erratic device operation, we kindly ask you to inform the manufacturer about this fact, either via an authorized seller or directly, using e-mail addresses and telephone numbers published at: www.eutonomy.com. Apart from the description of the observed malfunction, please provide the serial number of the euLINK gateway and the type of peripheral module connected to the gateway (if any). You can read the serial number from the sticker on the gateway enclosure and in the "Device info" menu on the OLED display. The serial number has the value of the MAC address suffix of the Ethernet port of the euLINK, so it can also be read

EN euLINK DALI 01

over the LAN. Our Service Department will do their best to solve the problem or your device will be admitted for guarantee or post-guarantee repair.

Guarantee Terms and Conditions

GENERAL PROVISIONS

1. The device is covered with a guarantee. Terms and conditions of the guarantee are outlined in this guarantee statement.
2. The guarantor of the Equipment is Eutonomy Sp. z o.o. Sp. Komandytowa based in Łódź (address: ul. Piotrkowska 121/3a; 90-430 Łódź, Poland), entered into the Register of Entrepreneurs of the National Court Register kept by the District Court for Łódź-Śródmieście in Łódź, XX Commercial Division of the National Court Register, under no. 0000614778, Tax ID No PL7252129926.
3. The guarantee is valid for a period of 24 months from the date the Equipment was purchased and covers the territory of EU and

EFTA countries.

4. This guarantee shall not exclude, limit or suspend the Customer rights resulting for the warranty for defects of the purchased goods.

OBLIGATIONS OF THE GUARANTOR

5. During the guarantee period the Guarantor is liable for defective operation of the Equipment resulting from physical defects thereof disclosed during the guarantee period.
6. The Guarantor's liability during the guarantee period includes the obligation to eliminate any disclosed defects free of charge (repair) or supply the Customer with the Equipment that is free of defects (replacement). Whichever of the above is chosen remains at sole Guarantor's discretion. If repair is not possible, the Guarantor reserves the right to replace the Equipment with a new or regenerated Equipment with parameters identical to a brand-new device.
7. If repair or replacement with the same type of the Equipment is not possible, the Guarantor can replace the Equipment with another one bearing identical or higher technical parameters.
8. The Guarantor does not reimburse the cost of purchasing the Equipment.

LOGGING AND PROCESSING COMPLAINTS

9. All complaints shall be lodged by telephone or via e-mail. We recommend using the telephone or on-line technical support provided by the Guarantor prior to entering a guarantee claim.

10. The proof of purchase of the Equipment is a basis for any claims.
11. After entering a claim via telephone or e-mail the Customer will be notified what reference number has been assigned to the claim.
12. In case of correctly entered complaints a representative of the Guarantor will get in touch with the Customer in order to discuss the details of delivering the Equipment to the service.
13. The Equipment the Customer is complaining about shall be made accessible by the Customer complete with all components and the proof of purchase.
14. In case of unjustified complaints the costs of delivery and receipt of the Equipment from the Guarantor shall be borne by the Customer.
15. The Guarantor can refuse to accept a complaint in the following cases:
 - a. In case of incorrect installation, improper or unintended use of the Equipment;
 - b. If the Equipment made accessible by the Customer is not complete;
 - c. If it is disclosed that a defect had been caused not by a material or manufacturing defect;
 - d. If the proof of purchase is missing.

GUARANTEE REPAIR

16. Subject to Clause 6, defects disclosed during the guarantee period will be eliminated within 30 working days of the date of delivering the Equipment to the Guarantor. In exceptional cases, e.g. missing spare parts or other technical obstacles, the period for performing a guarantee repair can be extended. The Guarantor will notify the Customer about any such situations. The guarantee period is extended by the time during which the Customer could not use the Equipment due to its defects.

EXCLUSION OF GUARANTOR'S LIABILITY

17. The Guarantor's liability stemming from the granted guarantee is limited to the obligations specified in this guarantee statement. The Guarantor will not be liable for any damages caused by defective operation of the Equipment. The Guarantor shall not be liable for any indirect, incidental, special, consequential or punitive damages, or for any other damages, including but not limited to loss of profits, savings, data, loss of benefits, claims by third parties and any property damage or personal injuries arising from or related to the use of the Equipment.
18. The guarantee shall not cover natural wear and tear of the Equipment and its components as well as product defects not arising from reasons inherent in the product – caused by improper installation or use of the product contrary to its intended purpose and instructions for use. In particular the guarantee shall not cover the following:
 - a. Mechanical damages caused by impact or fall of the Equipment;
 - b. Damages resulting from Force Majeure or external causes – also damages caused by malfunctioning or malicious software running on the installer's computer hardware;
 - c. Damages resulting from operation of the Equipment in conditions different than recommended in the instructions for use;
 - d. Damages caused by incorrect or faulty electrical installation (not consistent with the instructions for use) in the place of Equipment operation;
 - e. Damages resulting from carrying out repairs or introducing modifications by unauthorized persons.
19. If a defect is not covered by the guarantee, the Guarantor reserves the right to carry out repair at its sole discretion by

replacement of damaged components. Post-guarantee servicing is provided against payment.

Trademarks

All FIBARO system names referred to in this document are registered trademarks belonging to **Fibar Group S.A.** DALI is the registered trademark of **DIIA**.